

Patented Product

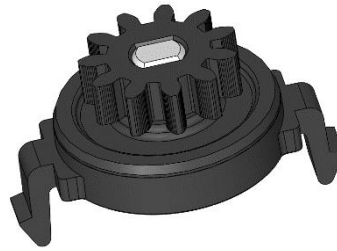

This damper is used in many applications - storage bins, sunglass holders, overhead bins, ashtrays, covers, and any other light to medium sliding or rotary applications.

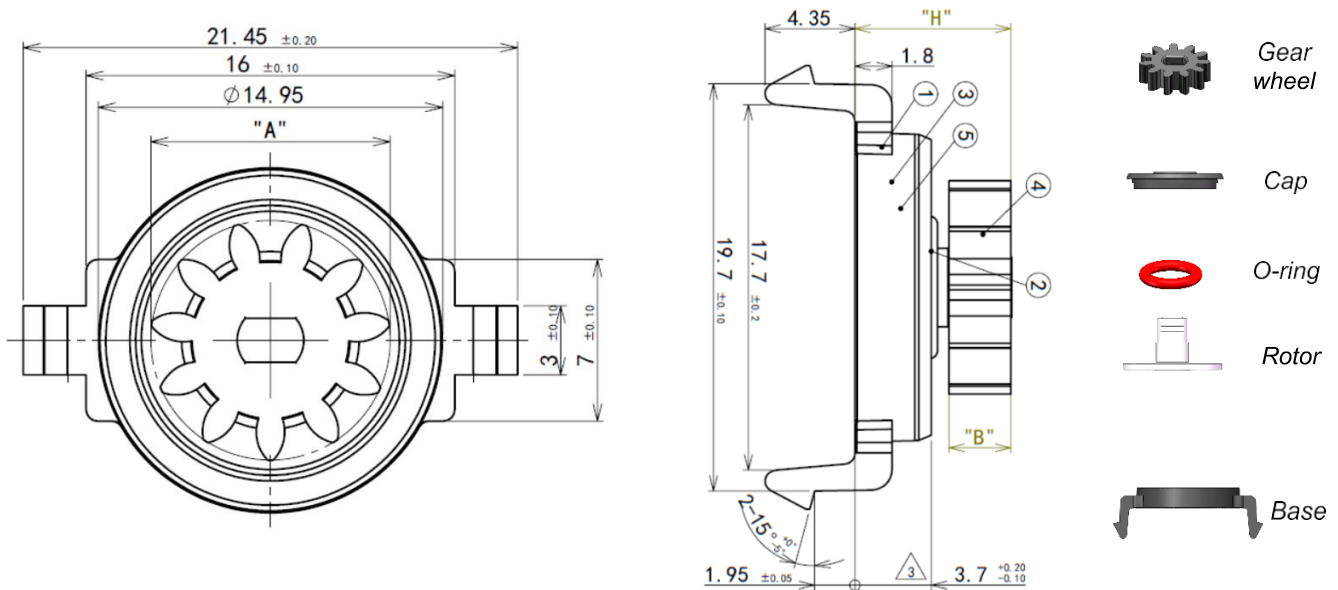

Gear Wheels	01	02	03	04	05	06				
Pressure angle [Deg]	20°	20°	14,5°	20°						
Module	0,8									
N. Teeth	11	16	13	11	16	10				
Outside circle Ø [mm]"A"	10,4	14	12	10,4	14,4	9,6				
Gear Height [mm]"B"	3	4,5	3	4,5	3	3,6				
Total Height [mm]"H"	7.6±0.40	9.1±0.50	7.6±0.40	9.1±0.50	7.6±0.40	7.9±0.50				

Suggested Housing

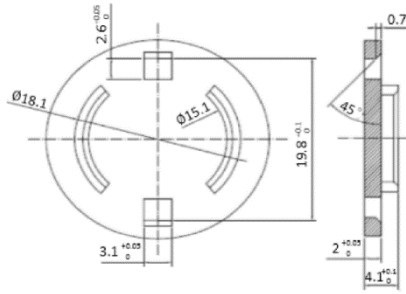

Sample Application

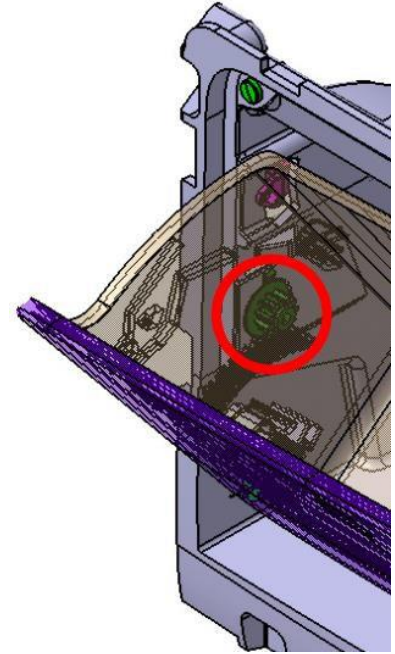

Mountings to avoid

Axial load

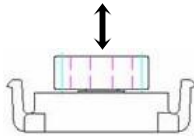

Angular

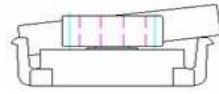

Radial load

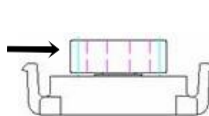

Misalignment

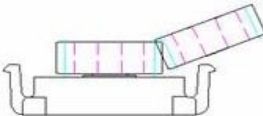

Working Conditions

Temperature	-40°C up to +90°C
Lifetime	100.000 cycles at 20 rpm and RT (1 cycle = 0°+360°+0°)



Bill Of Materials

Gear	POM
Rotor	POM
Base	PC
Cap	PC
O-Ring	Silicone oil

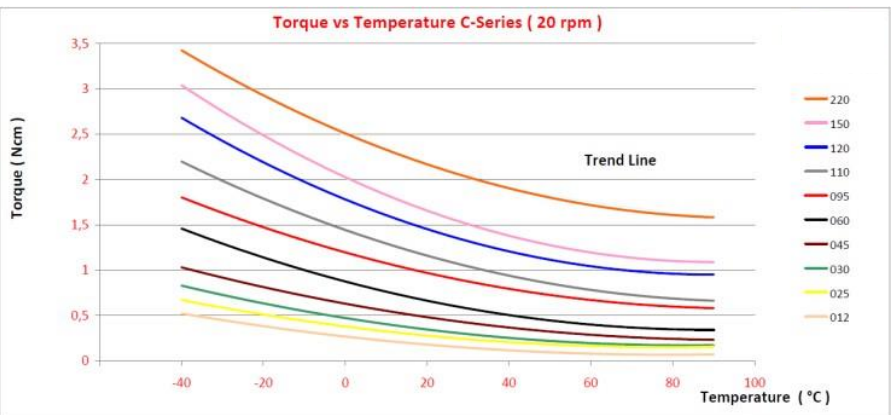

Product Key

Type
D01:Classic (free rotating)











Fixing
011:holes thin body

D01011

01

045

Gear Wheel
01: 11 teeth – lower ISO- module 0,8 – 3 mm height
02: 16 teeth - module 0,8-4,5 mm height
03: 13 teeth - module 0,8 – 3 mm height – 14,5° pressure angle
04: 11 teeth - module 0,8-4,5 mm height
05: 16 teeth - module 0,8 – 3 mm height
06: 10 teeth - module 0,8 – 3,5 mm height

Torque [Ncm] (•)	Colour
025 = 0,25 Ncm ± 0,08 at 20 rpm and RT (•)	
030 = 0,30 Ncm ± 0,10 at 20rpm and RT (•)	
045 = 0,45 Ncm ± 0,12 at 20rpm and RT (•)	
060 = 0,60 Ncm ± 0,17 at 20 rpm and RT (••)	
060 = 0,80 Ncm ± 0,15 at 20 rpm and RT (••)	
095 = 0,95 Ncm ± 0,18 at 20 rpm and RT (•••)	
110 = 1,10 Ncm ± 0,20 at 20 rpm and RT (•••)	
120 = 1,20 Ncm ± 0,20 at 20 rpm and RT (•••)	
150 = 1,50 Ncm ± 0,25 at 20 rpm and RT (•••)	
220 = 2,20 Ncm ± 0,35 at 20 rpm and RT (•••)	

(•) = Torque 100% checked in production at 160 rpm and RT
 (••) = Torque 100% checked in production at 120 rpm and RT
 (•••) = Torque 100% checked in production at 80 rpm and RT

The official 2D drawing is the only valid technical documentation.

All the characteristics and dimensions written into this datasheet may in fact change and so will not be valid anymore.

All products are 100% tested on the torque value.

Bases, gear, wheels, torques and colors can be combined, having a design flexibility.

Custom designs are also available

